

# TORONTA G

## Typ G

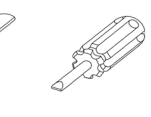

1	941	375	16	1	1002	1/2
2	941	375	16	1	1003	1/2
3	1028	375	16	1	1004	1/2
4	995	355	16	1	1005	1/2
5	995	65	16	1	1007	1/2
6	995	70	16	1	1008	1/2
7	995	70	16	1	1009	1/2
8	995	70	16	1	1030	1/2
9	218	354.5	16	1	1031	1/2
10	218	354.5	16	1	1032	1/2
11	995	345	16	1	N/A	1/2
12	350	110	16	1	1034	1/2
13	841.5	110	16	1	1035	1/2
14	350	110	16	1	1036	1/2
15	995	65	16	1	1001	1/2
16	873	355	3	1	N/A	1/2
17	1009	232	3	1	N/A	1/2
18	1009	360	3	1	N/A	1/2
19	1009	287	3	1	N/A	1/2
20	617	447	16	1	3037	2/2
21	617	447	16	1	3039	2/2
22	896	202	16	1	3033	1/2
23	1028	65	19	1	4016	1/2
24	897	65	19	1	4017	1/2
25	897	65	19	1	4018	1/2

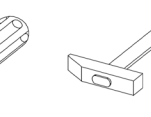
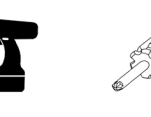
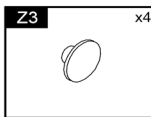
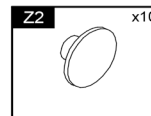
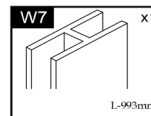
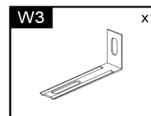
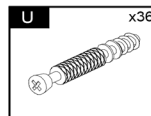
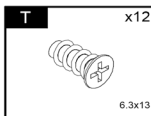
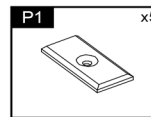
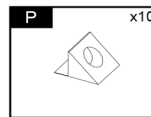
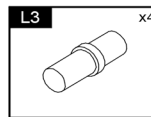
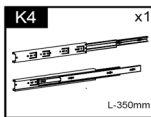
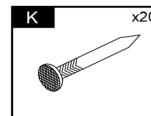
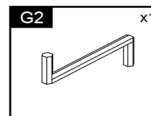
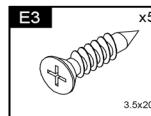
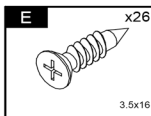
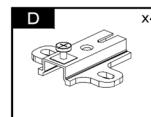
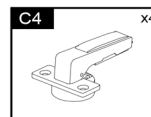
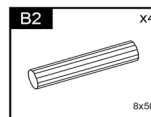
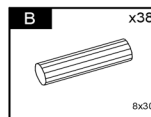
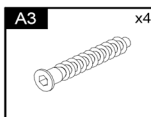
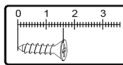
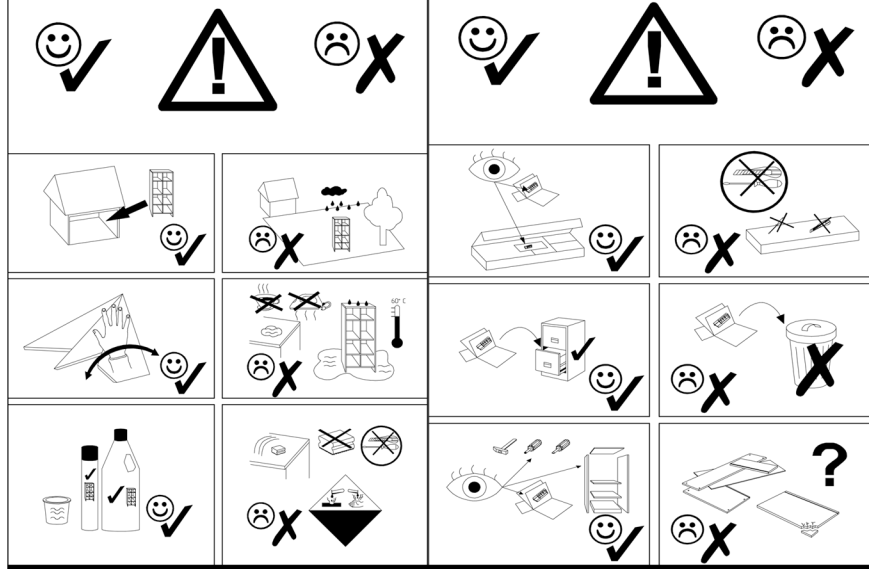
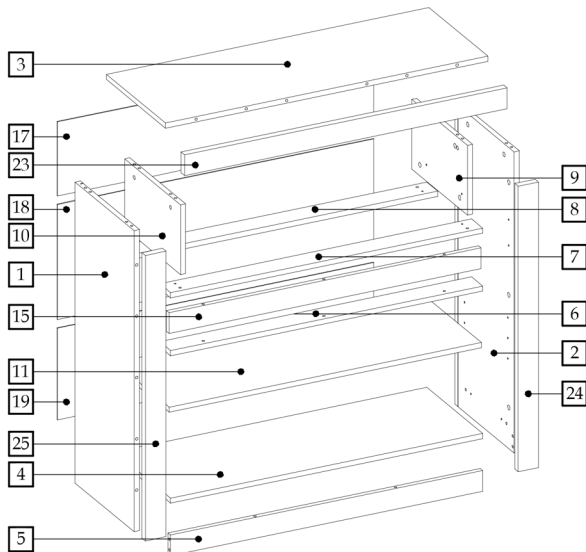
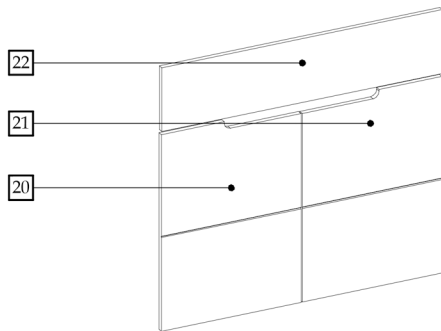
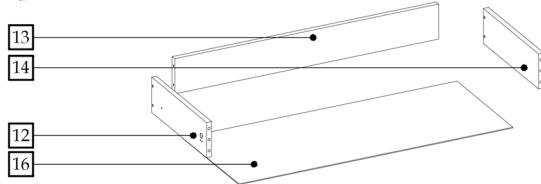
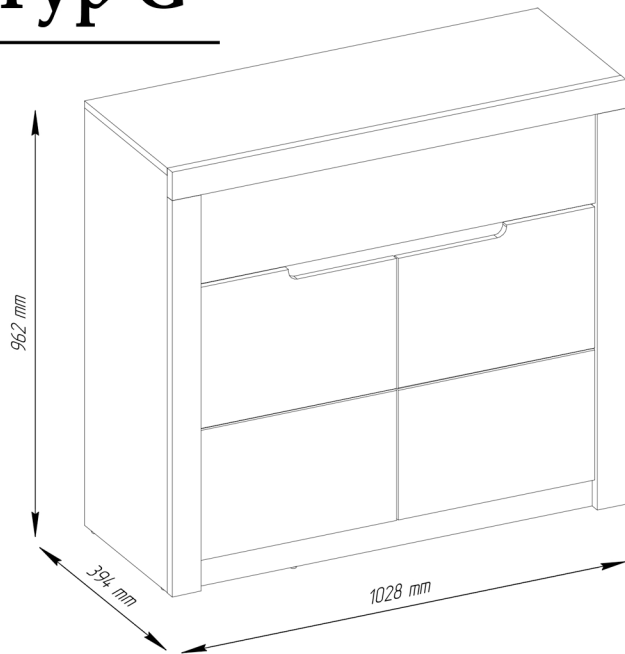
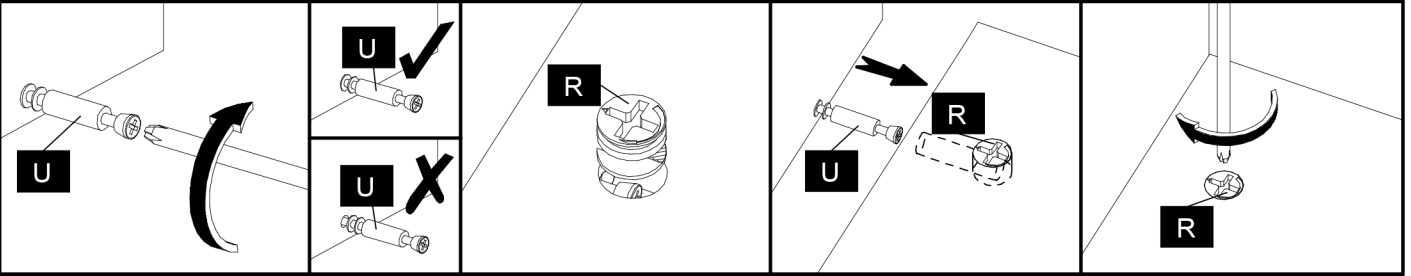

1

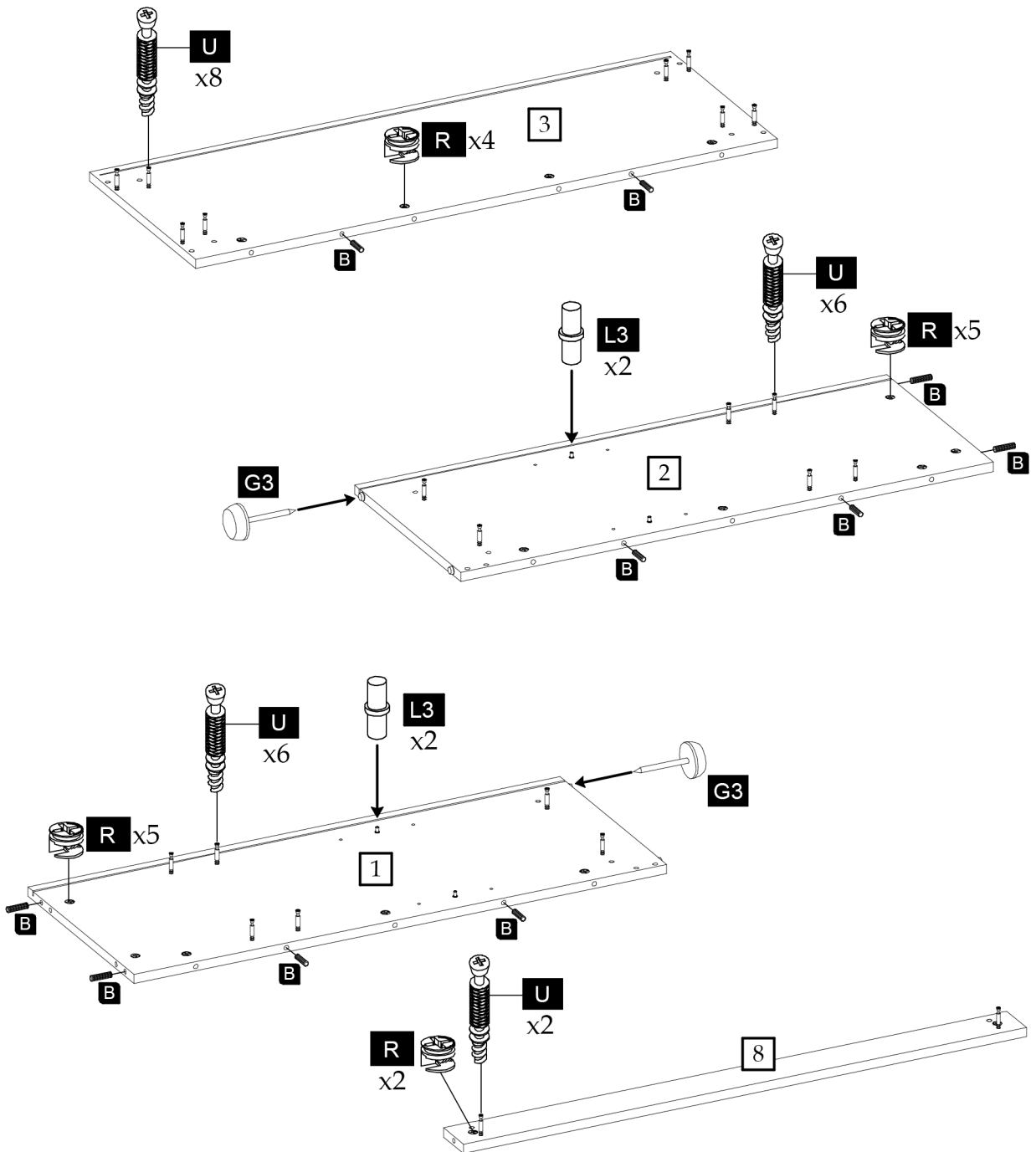

2

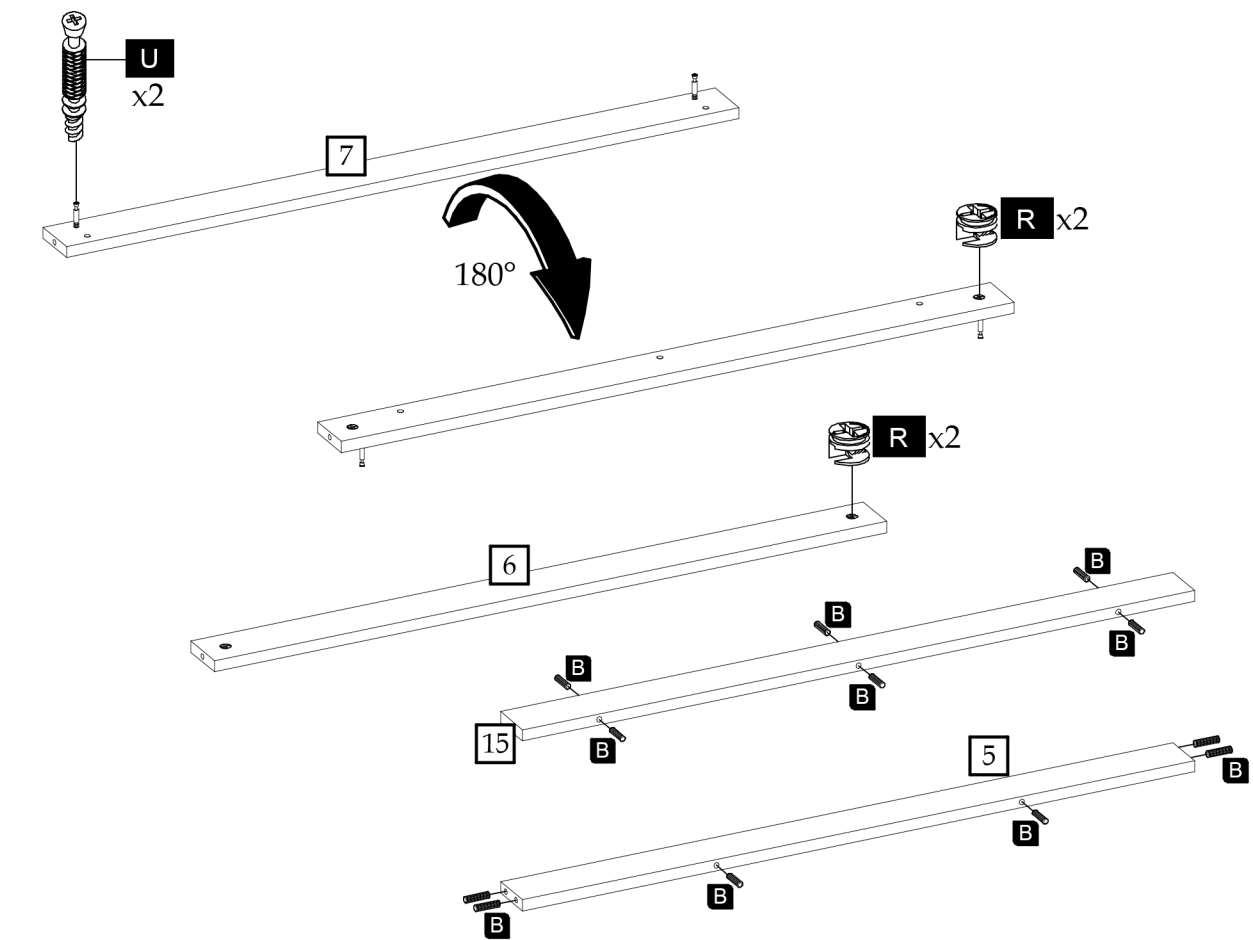

3

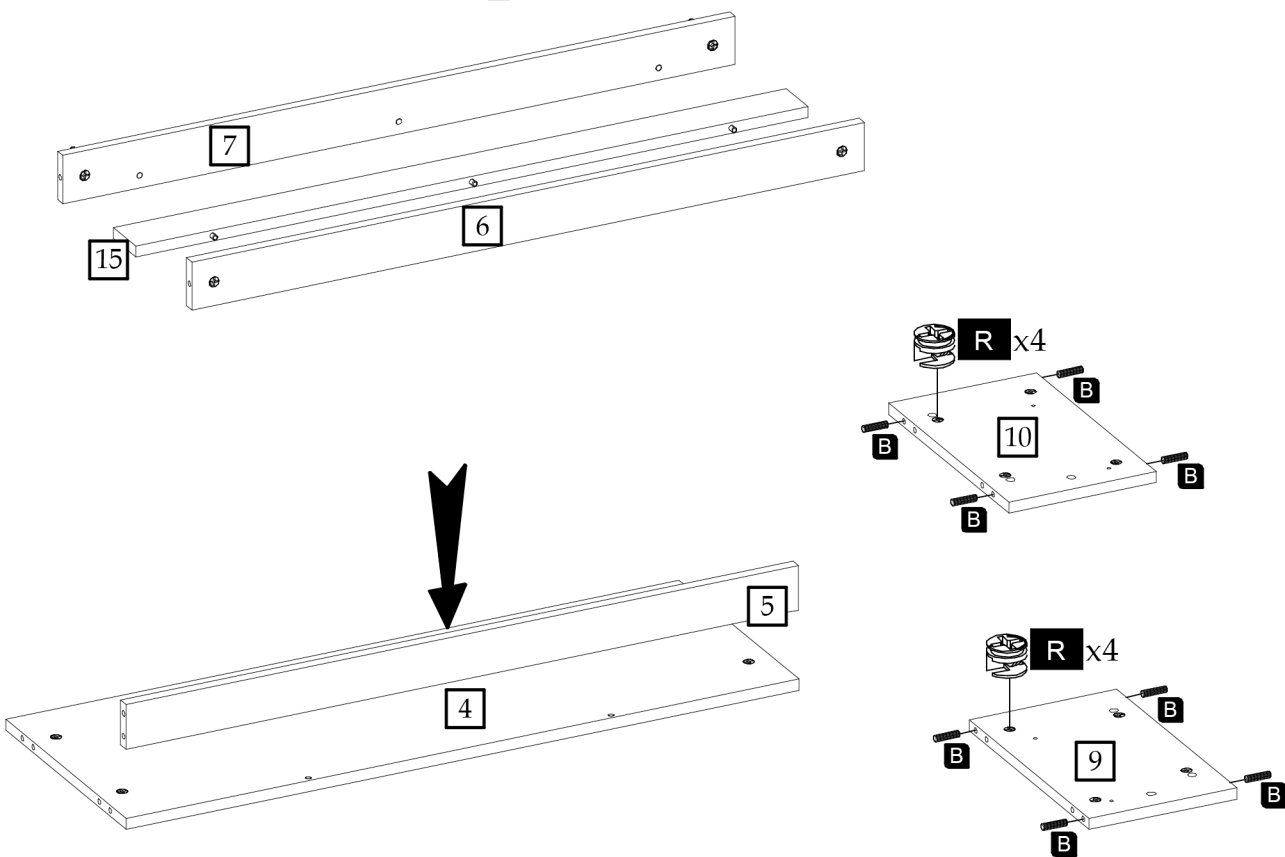

4

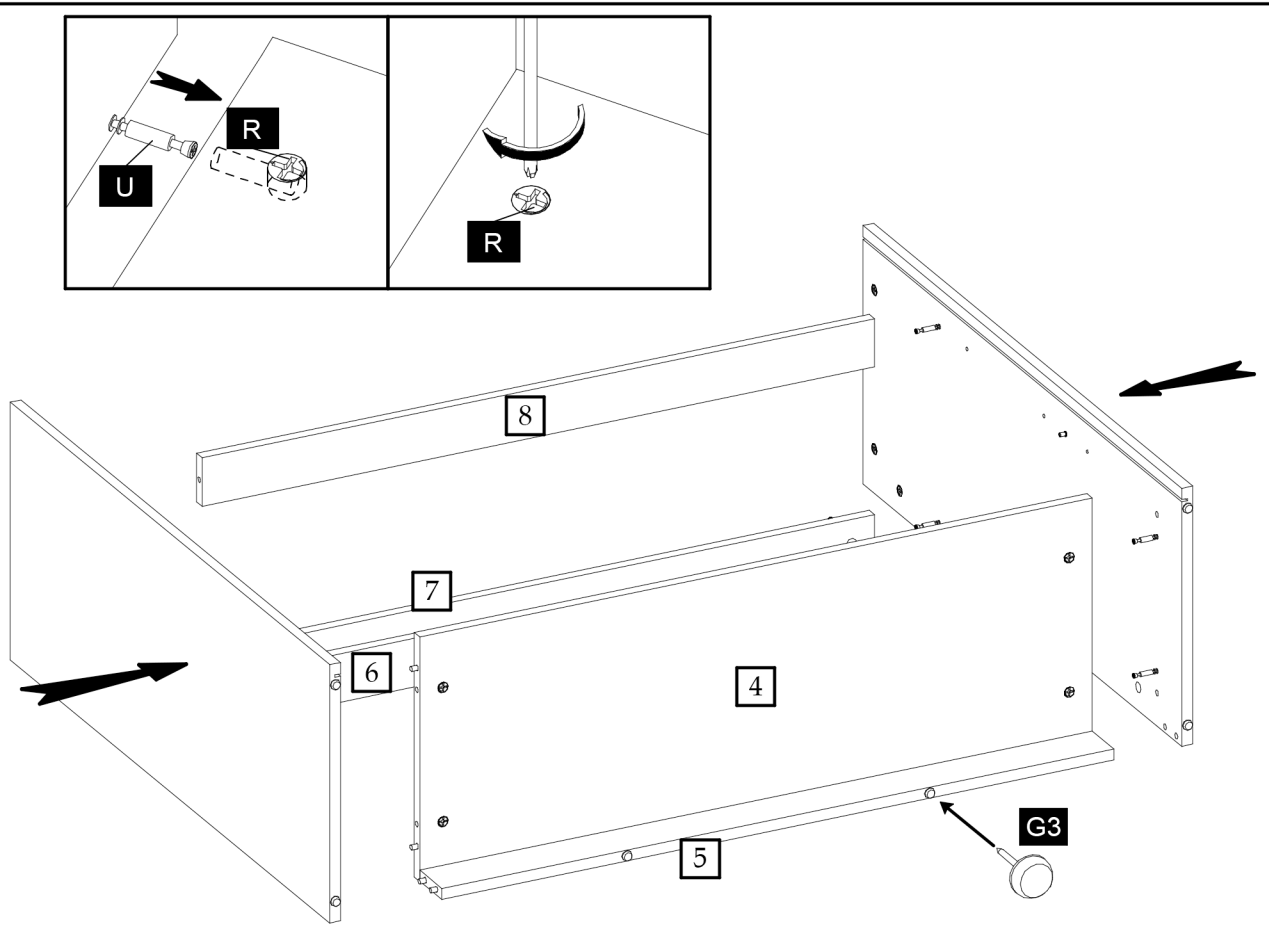

5

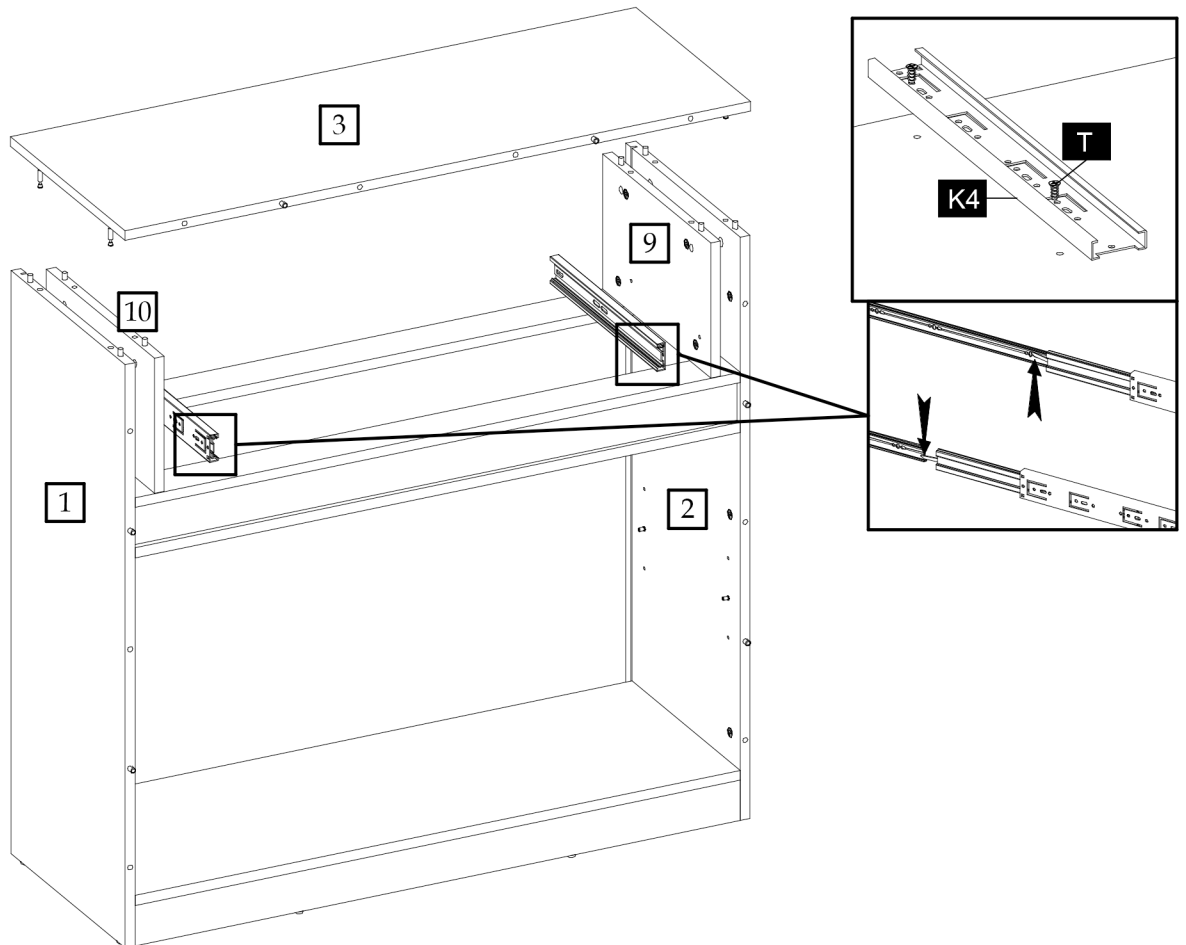

6

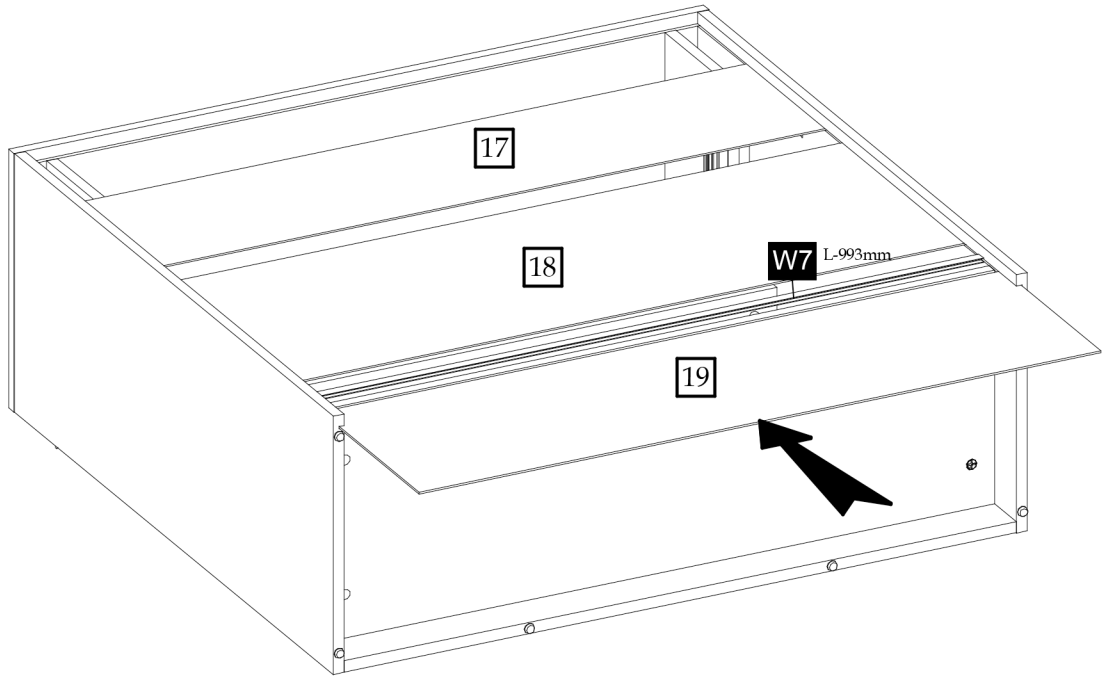

7

